



*Photo may vary from actual product.

RoHS compliant

Part Number	MSMF102L1C8
Product	Servo Motor
Details	Low inertia, Connector type
Product name	MINAS A6 Family Servo Motor
Features	50 W to 22 kW, Input power supply for Driver: Voltage DC 24 V/48 V · AC 100 V/200 V/400 V, 23 bit Absolute/Incremental · battery-less Absolute/Incremental encoder, Frequency response 3.2 kHz

Spec Detail

Item	Specifications
Part Number	MSMF102L1C8
Details	Low inertia, Connector type
Family Name	MINAS A6
Series	MSMF Series
Type	Low inertia
Protection class	IP67
About Enclosure	Except rotating portion of output shaft and connecting pin part of the motor connector and the encoder connector.
Environmental Conditions	For more details, please refer to the instruction manual.
Flange sq. dimension	100 mm sq.
Flange sq. dimension (Unit:mm)	100
Motor lead-out configuration	Connector
Motor encoder connector	Motor connector: JL10, Encoder connector: Large size JL10
About Motor encoder connector	Connector JL10 (Large size): Also applicable to screwed type
Power supply capacity (kVA)	2.4
Voltage specifications	200 V
Rated output	1000 W
Rated current (A (rms))	6.6
Holding brake	without
Mass (kg)	3.6
Oil seal	with protective lip
Shaft	Round

Before purchasing our products

- This datasheet is downloaded from Panasonic Automation Controls Website.
- Specifications and design of the products are subject to change without notice for the product improvement.
- For more detail of this product, please contact us or consult to the dealer from whom you have purchased this product.

Rated torque (N · m)	3.18
Continuous stall torque (N · m)	3.82
Momentary Max. peak torque (N · m)	9.55
Max. current (A (o-p))	28
Regenerative brake frequency (times/min)	Without option :No limit With option :No limit Option (External regenerative resistor) Part No. : DV0P4284
About regenerative brake frequency	Please refer to the details of [Motor Specification Description] , Note: 1, and 2.
Rated rotational speed (r/min)	3000
Rated rotational Max. speed (r/min)	5000
Moment of inertia of rotor ($\times 10^{-4}$ kg · m ²)	2.15
Recommended moment of inertia ratio of the load and the rotor	15 times or less
About recommended moment of inertia ratio of the load and the rotor	Please refer to the details of [Motor Specification Description] ,Note: 3.
Rotary encoder: specifications	23-bit Absolute/Incremental system
Notice	When using a rotary encoder as an incremental system (not using multi-turn data), do not connect a battery for absolute encoder.
Rotary encoder: Resolution	8388608

Permissible load

Item	Specifications
During assembly: Radial load P-direction (N)	980
During assembly: Thrust load A-direction (N)	588
During assembly: Thrust load B-direction (N)	686
During operation: Radial load P-direction (N)	490
During operation: Thrust load A, B-direction (N)	196
About permissible load	For details, refer to the [Motor Specification Description] "Permissible Load at Output Shaft".

[A6 Family Motor Specification Description\(PDF\)](#)

Before purchasing our products

- This datasheet is downloaded from Panasonic Automation Controls Website.
- Specifications and design of the products are subject to change without notice for the product improvement.
- For more detail of this product, please contact us or consult to the dealer from whom you have purchased this product.

Applicable Driver

Part Number	Series	Type	I/F Classification of type	Frame	Supply voltage
MDDL N55NE	A6NE series	RTEX, Ultra high-speed Network (Basic type)	RTEX	D-Frame	Single/3-phase 200 V
MDDL N55SE	A6SE series	Position control type	Pulse train only	D-Frame	Single/3-phase 200 V
MDDL N55SG	A6SG series	RS485/RS232 Communication type	Pulse, Modbus (RS485 /RS232)	D-Frame	Single/3-phase 200 V
MDDL T55NF	A6NF series	RTEX, Ultra high-speed Network type (Multi type)	RTEX	D-Frame	Single/3-phase 200 V
MDDL T55SF	A6SF series	Multifunction type	Analog /Pulse, Modbus (RS485 /RS232)	D-Frame	Single/3-phase 200 V

[A6 Family Table of Part Numbers and Options\(PDF\)](#)

* The A6SE-series (position control type) driver does not support absolute systems. It can only be used with incremental systems.

Before purchasing our products

- This datasheet is downloaded from Panasonic Automation Controls Website.
- Specifications and design of the products are subject to change without notice for the product improvement.
- For more detail of this product, please contact us or consult to the dealer from whom you have purchased this product.

Torque characteristics

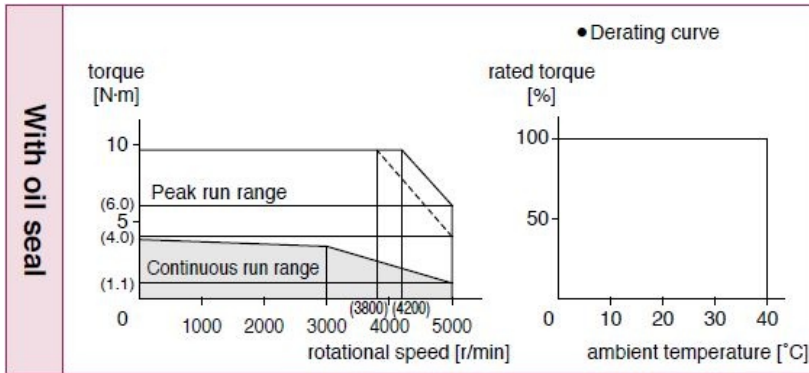

Dotted line represents the torque at 10 % less supply voltage.

Before purchasing our products

- This datasheet is downloaded from Panasonic Automation Controls Website.
- Specifications and design of the products are subject to change without notice for the product improvement.
- For more detail of this product, please contact us or consult to the dealer from whom you have purchased this product.

Dimensions

- ① Encoder connector (Large size JL10)
- ② Motor connector

● Motor model Mass: 3.6 kg

Power supply	Shaft	with oil seal	with protective lip
200 V	Round	MSMF102L1C6	MSMF102L1C8
	Key-way	MSMF102L1G6	MSMF102L1G8

● Dimensions are subject to change without notice. Contact us or a dealer for the latest information.

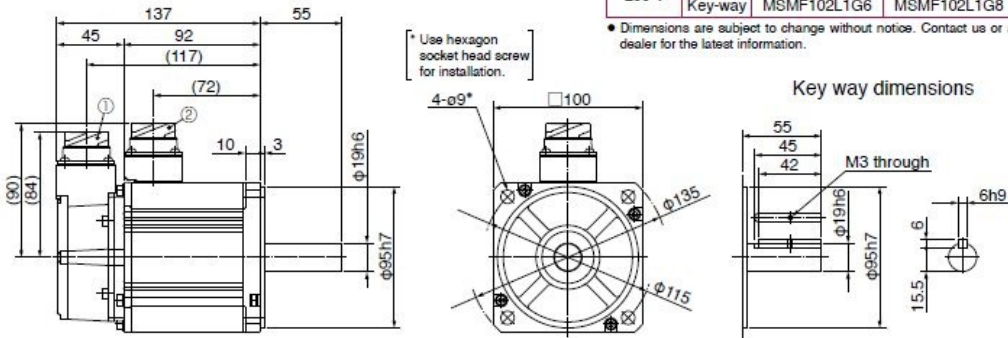

Before purchasing our products

- This datasheet is downloaded from Panasonic Automation Controls Website.
- Specifications and design of the products are subject to change without notice for the product improvement.
- For more detail of this product, please contact us or consult to the dealer from whom you have purchased this product.

Before Purchasing and Using the Products (Motors for FA & Industrial Application)

Specifications and design of the products displayed on this website are subject to change without notice for the product improvement. (including specification change, manufacturing location change, End Of Sales, End Of Life). Therefore, be sure to request and confirm in advance the most current specifications, which explain the specifications in detail, before the final stage of your design, purchasing or use for any application.

Safety Precautions

- Important Notes on exporting this product or equipment containing this product;
If the end-user or application of this product is related to military affairs or weapons, its export may be controlled by "Foreign Exchange and Foreign Trade Control Law" of Japan where export license will be required before product can be exported from Japan.
- This product is designed and manufactured for use in General Purpose Industrial Equipment and it is not intended to be used in equipment or system that may cause personal injury or death.
- All servicing such as installation, wiring, operation, maintenance and etc., should be performed by qualified personnel only.
- Tighten mounting screws with an adequate torque by taking into consideration strength of the screws and the characteristics of material to which the product will be mounted. Over tightening can damage the screw and/or material; under tightening can result in loosening.
*Example: apply 2.7 N·m – 3.3 N·m torque when tightening steel screw (M5) to steel surface.
- Install safety equipment to prevent serious accidents or loss that is expected in case of failure of this product.
- Consult us before using this product under such special conditions and environments as nuclear energy control, aerospace, transportation, medical equipment, various safety equipments or equipments which require a lesser air contamination.
- We have been making the best effort to ensure the highest quality of our products, however, some applications with exceptionally large external noise disturbance and static electricity, or failure in input power, wiring and components may result in unexpected action. It is highly recommended that you make a fail-safe design and secure the safety in the operative range.
- If the motor shaft is not electrically grounded, it may cause an electrolytic corrosion to the bearing, depending on the condition of the machine and its mounting environment, and may result in the bearing noise. Checking and verification by customer is required.
- Failure of this product depending on its content may generate smoke of about one cigarette. Take this into consideration when the application of the machine is clean room related.
- Please be careful when using the product in an environment with high concentrations of sulfur or sulfuric gases, as sulfuration can lead to disconnection from the chip resistor or a poor contact connection.
- Do not input a supply voltage which significantly exceeds the rated range to the power supply of this product. Failure to heed this caution may lead to damage of the internal parts, causing smoke and/or fire and other troubles.
- The user is responsible for matching between machine and components in terms of configuration, dimensions, life expectancy, characteristics, when installing the machine or changing specification of the machine. The user is also responsible for complying with applicable laws and regulations.
- Manufacturer's warranty will be invalid if the product has been used outside its stated specifications.
- Component parts are subject to minor change to improve performance.
- Read and observe the instruction manual to ensure correct use of the product.

Warranty period

The warranty period is one year from the date of purchase or 18 months from the month of manufacture in our plant.

Warranty information

• Should any defect develop during warranty period under standard service conditions as described in the manual, the company agrees to make repairs free of charge. Even during warranty period, the company makes fee-based repair on product containing:

- [1] Failure or damage due to misuse, improper repair or alteration.
- [2] Failure or damage due to falling, or damage during transportation, after the original delivery
- [3] Defects resulting from neglect of the specification in use of the product.
- [4] Failure or damage due to unregulated voltage and fire, and act of natural disasters such as earthquake, lightning, wind, flood and salt pollution.
- [5] Defects resulting from invasion of foreign materials such as water, oil and metal pieces. Parts exceeding their standard lifetime specified in this document are excluded.

• The company shall not be liable for any indirect, incidental or consequential damage or loss of any nature that may arise in connection with the product

Before purchasing our products

- This datasheet is downloaded from Panasonic Automation Controls Website.
- Specifications and design of the products are subject to change without notice for the product improvement.
- For more detail of this product, please contact us or consult to the dealer from whom you have purchased this product.